

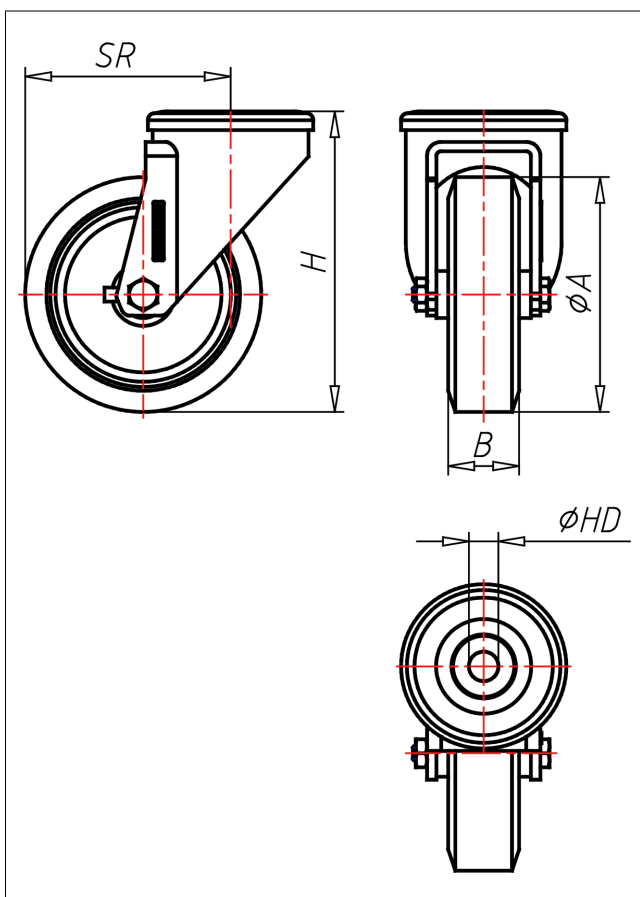

XR/XRS-A/ABX

Lenkrolle



XR-A



LENKROLLE	LENKROLLE MIT TOTALFESTSTELLER																					
<ul style="list-style-type: none"> • geräuscharmer Lauf • geringer Rollwiderstand • abrieb- und reißfest • hohe Stoßfestigkeit • leichte Reinigung • sehr beständig gegen viele aggressive Medien <p>Guss-Polyurethan Felge Polyamid 6 → Seite 252</p>	<p>zweifaches Kugellager - vernietet, Staubschuttring, Edelstahl AISI 304 poliert, Laufkugeln AISI 420, Radachse verschraubt → Seite</p>	<p>AUSWAHLHILFE:</p> <table border="1"> <tr> <td>leicht lenkend</td> <td>-</td> <td>+</td> <td>++</td> </tr> <tr> <td>verschleißarm</td> <td>x</td> <td></td> <td></td> </tr> <tr> <td>stoßfest</td> <td></td> <td></td> <td>x</td> </tr> <tr> <td>bodenschonend</td> <td></td> <td></td> <td>x</td> </tr> <tr> <td>witterungsbeständig</td> <td></td> <td></td> <td>x</td> </tr> </table>	leicht lenkend	-	+	++	verschleißarm	x			stoßfest			x	bodenschonend			x	witterungsbeständig			x
leicht lenkend	-	+	++																			
verschleißarm	x																					
stoßfest			x																			
bodenschonend			x																			
witterungsbeständig			x																			

Technische Details

ORDERNO (Artikel-nummer)	XR 80 A
WDAB (Rad-Ø A x Breite B / mm)	80x24
LC (Tragkraft / kg)	120
H (Bauhöhe H / mm)	106
HD (Loch-Ø / mm)	12.5
SR (Schwenkradius / mm)	73
WB (Radlager)	Polyamid-Gleitlager